

Hazardous Area Explosion-proof Transmitter Model E-10, E-11

INSTRUMENTS • CONTROLS • VALVES

CLICK TO VISIT OUR WEBSITE

ARCO

Engineering, Inc.
SINCE 1954
www.arcoengineering.com

3317 Gilmore Industrial Blvd.
Louisville, KY 40213

Ph: (502) 966-3134
Fx: (502) 966-3135



Meets ANSI / ISA 12.27.01-2003
single seal requirements - no
dual seal required

Applications

- Wellhead monitoring
- Refining, chemical, petrochemical
- Offshore platforms, pipelines
- Natural gas compressors

Special Features

- FM-approved explosion-proof for Class I
Division 1 hazardous locations
- Available with 4 ... 20 mA, 2-wire or 1 ... 5 V,
3-wire low power output signals
- Engineered to withstand harsh environments
- NACE MR0175 compliant wetted parts
- Retrofits many existing oil and gas applications



Left: E-10 NPT pressure transmitter with cable
Right: E-11 flush diaphragm pressure transmitter
with optional flying leads

The E-10 and E-11 explosion-proof pressure transmitters are specifically designed to meet the durability and performance requirements of oil and gas pressure monitoring applications.

These pressure transmitters feature an industry standard 4-20 mA 2-wire or 1-5V 3-wire low power signal output and NEMA 4X (IP67) ingress protection. They are extremely resistant to pressure spikes, vibration and moisture intrusion. NACE MR-01-75 compliant wetted parts provides extra resistance against sulfide stress cracking when exposed to media containing sulphur. Both are available with a factory sealed epoxy flying lead assembly for easier installation.

The E-10 features an NPT process connection with an all-welded stainless steel measuring cell for media compatibility.

There are no internal soft sealing materials that may react with the media or deteriorate over time.

The E-11 features a flush diaphragm process connection. This flat sensing surface is specifically designed for the measurement of viscous fluids or media containing solids that may clog the NPT process connection.

The transmitters are engineered to meet Class I, Division 1 explosion-proof protection for installation in hazardous environments. Each transmitter undergoes extensive quality control testing and calibration to achieve a linearity of $\leq 0.25\%$ full scale. In addition, each pressure transmitter is temperature compensated to assure accuracy and long-term stability even when exposed to severe ambient temperature variations.

Specifications

Type E-10 / E-11

| | | | | | | | | | |
|--|-----------|-----------|---|--|-----------------|-------------------------|------------------------|-------------------------|-------------------------|
| Pressure range | 5 psi | 10 psi | 15 psi | 25 psi | 30 psi | 60 psi | 100 psi | 200 psi | 300 psi |
| Maximum pressure* | 29 psi | 58 psi | 72 psi | 145 psi | 145 psi | 240 psi | 500 psi | 1,160 psi | 1,160 psi |
| Burst pressure** | 35 psi | 69 psi | 87 psi | 170 psi | 170 psi | 290 psi | 600 psi | 1,390 psi | 1,390 psi |
| Pressure range | 500 psi | 1,000 psi | 1,500 psi | 2,000 psi | 3,000 psi | 5,000 psi | 8,000 psi ¹ | 10,000 psi ¹ | 15,000 psi ¹ |
| Maximum pressure* | 1,160 psi | 1,740 psi | 2,900 psi | 4,600 psi | 7,200 psi | 11,600 psi | 17,400 psi | 17,400 psi | 21,750 psi |
| Burst pressure** | 5,800 psi | 7,970 psi | 11,600 psi | 14,500 psi | 17,400psi | 24,650 psi ² | 34,800 psi | 34,800 psi | 43,500 psi |
| {Vacuum, gauge pressure, compound ranges and absolute pressure ranges are available} | | | | | | | | | |
| Materials | | | | | | | | | |
| ■ Wetted parts | | | Nace compliant ⁴ | | | | | | |
| ➢ Model E-10 | | | Stainless steel (≥ 300 psi stainless steel and Elgiloy) | | | | | | |
| ➢ Model E-11 | | | Stainless steel | | | | | | |
| | | | O-ring: NBR {Viton®} | | | | | | |
| ■ Case | | | Stainless steel | | | | | | |
| Internal transmission fluid | | | Synthetic oil (only for pressure ranges up to 300 psi or flush diaphragm units) | | | | | | |
| Power supply U _B | | DC V | 10 < U _B < 30 for 4 ... 20 mA, 2-wire 6 < U _B < 30 for 1 ... 5 V, 3 wire low power version | | | | | | |
| Signal output and maximum load R _A | | | 4 ... 20 mA, 2-wire R _A ≤ (U _B - 10 V) / 0.02 A with R _A in Ohm and U _B in Volt 1 ... 5 V, 3-wire R _A > 10 kOhm | | | | | | |
| Response time (10 ... 90 %) | | ms | ≤ 1 (≤ 10 ms when media temperatures are below -22 ° F (-30 ° C) for pressure ranges up to 300 psi or with flush diaphragm) | | | | | | |
| Accuracy ³⁾ | | % of span | ≤ 0.25 (BFSL) | | | | | | |
| | | % of span | ≤ 0.5 (limit point calibration) | | | | | | |
| Hysteresis | | % of span | ≤ 0.1 | | | | | | |
| Non-repeatability | | % of span | ≤ 0.1 | | | | | | |
| 1-year stability | | % of span | ≤ 0.2 (at reference conditions) | | | | | | |
| Permissible temperature of | | | | | | | | | |
| ■ Medium | | | -22 ... +212 °F | {-40 ... +221 °F} | -30 ... +100 °C | {-40 ... +105 °C} | | | |
| ■ Ambient | | | -22 ... +212 °F | {-40 ... +221 °F} | -30 ... +100 °C | {-40 ... +105 °C} | | | |
| ■ Storage | | | -40 ... +221 °F | {-58 ... +221 °F} | -40 ... +105 °C | {-50 ... +105 °C} | | | |
| Compensated temp. range | | | 32 ... +176 °F | | | 0 ... +80 °C | | | |
| Temperature coefficients in compensated temp range | | | | | | | | | |
| ■ Mean TC of zero | | | % of span | ≤ 0.2 / 10 K (< 0.4 for pressure range < 100 InWC) | | | | | |
| ■ Mean TC of range | | | % of span | ≤ 0.2 / 10 K | | | | | |
| EMI specifications | | | 89/336/EWG interference emission and immunity see EN 61 326 | | | | | | |
| Approval authority | | | <ul style="list-style-type: none"> ■ Factory mutual (FM / CSA) explosion-proof for: Class I, Division 1, Groups A, B, C and D ■ Dust ignition-proof for: Class II / III, Division 1, Groups E, F and G FM Standards according to class number 3600, 3615 and 3810 | | | | | | |
| HF-immunity | | V/m | 10 | | | | | | |
| Burst | | KV | 4 | | | | | | |
| Shock resistance | | g | 1,000 according to IEC 60068-2-27 (mechanical shock) | | | | | | |
| Vibration resistance | | g | 20 according to IEC 60068-2-6 (vibration under resonance) | | | | | | |
| Wiring protection | | | Protected against reverse polarity, over voltage and short circuiting | | | | | | |
| Ingress protection | | | NEMA 4X / IP 67 | | | | | | |
| Weight | | lb | Approximately 0.4 | | | | | | |

* Pressure applied up to the maximum rating will cause no permanent change in specifications but may lead to zero and span shifts

**Exceeding the burst pressure may result in destruction of the transmitter

- 1) Only Type E-10.
 - 2) For Type E-11: the burst pressure is limited to 21,000 psi unless the pressure seal is accomplished by using the sealing ring underneath the hex.
 - 3) Includes non-linearity, hysteresis and repeatability. Limit point calibration performed in vertical mounting position with pressure connection facing down.
 - 4) Wetted parts comply with recommendations per NACE MR0175. Environmental limits apply to certain materials. Consult latest standard for details.
- { } Items in curved brackets are options available at additional cost.

Dimensions in inches (mm)

1/2 male conduit with 6 foot (1.8 m) cable and free ends
NEMA 4X (IP 67)
Order code: 2X

1/2 male conduit with 6 foot (1.8 m) flying leads NEMA 4X (IP 67)
Order code: 3X

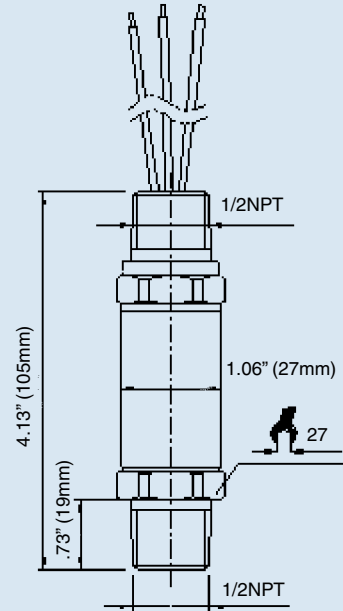
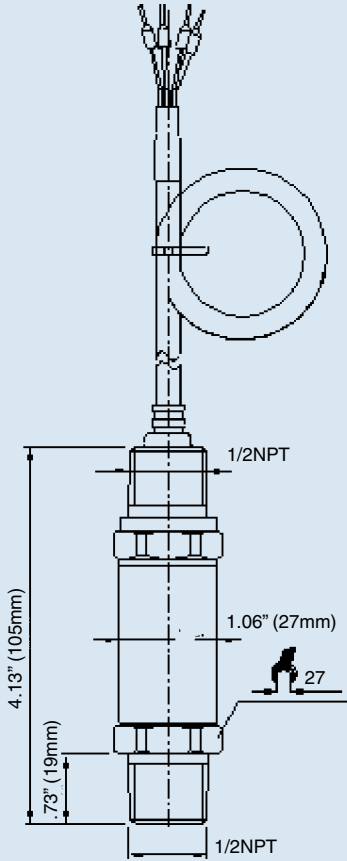

Pressure connections

1/4 NPT male
Order code: NB

1/2 NPT male
Order code: ND

G 1/2 male
EN 837
Order code: GD

G 1/4 male
EN 837
Order code: GB

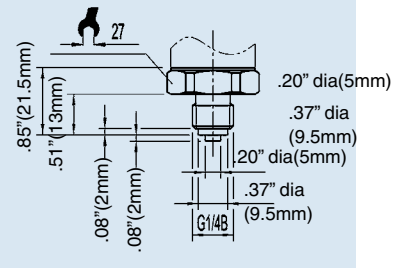
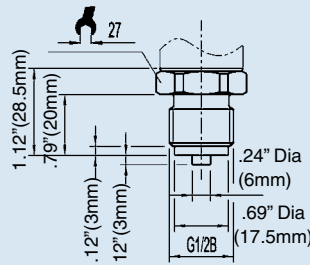
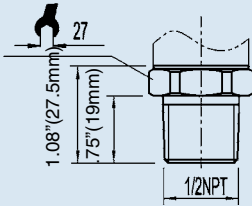
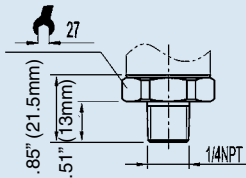

E-11 flush diaphragm pressure connections

E-11 G 1
50 InWC to 25 psi
Order code: 85

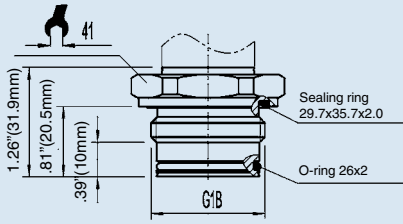

E-11 G 1/2
30 psi to 8,000 psi
Order code: 86

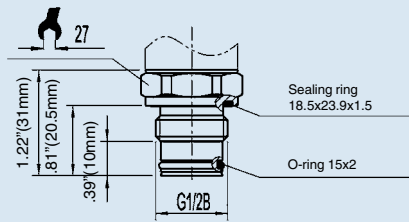

Matching P-1 weld insert adapters for E-11 flush diaphragm transmitters

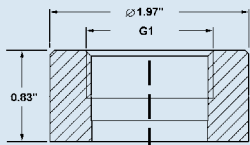

P-1 G1 weld insert adapter
Part # 1206974
for pressure ranges ≤ 25 psi

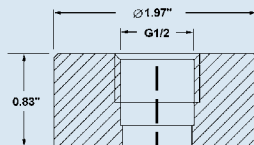

P-1 G1/2 weld insert adapter
Part # 1097008
for pressure ranges ≥ 30 psi

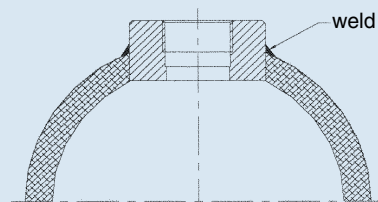

Cross section view of P-1 adapter installed in pipe.

Wiring

6 foot (1.82m)
cable or flying leads

2-wire system

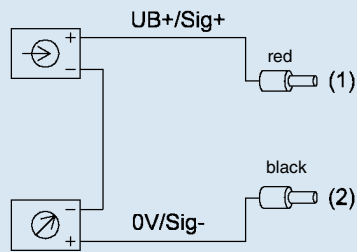

shield - ground

3-wire system

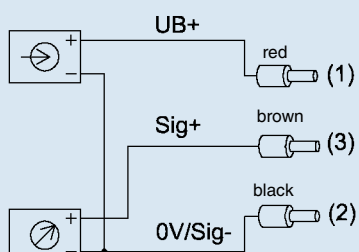

Green - ground

Legend:

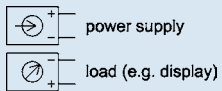

Sig+ output signal positive
UB+ power supply positive
0V power supply negative
Sig- output signal negative

