

General Purpose Pressure Transmitters with NEMA 4X Integral Junction Box Models F-20, F-21

INSTRUMENTS • CONTROLS • VALVES

CLICK TO VISIT OUR WEBSITE

ARCO

Engineering, Inc.
SINCE 1954
www.arcoengineering.com

3317 Gilmore Industrial Blvd.
Louisville, KY 40213

Ph: (502) 966-3134
Fx: (502) 966-3135

Applications

- Chemical industry
- Food industry
- Pharmaceutical industry
- Corrosive environments
- Mechanical engineering

Special Features

- Pressure ranges from 50 InWC to 15,000 psi
- 4-20mA and voltage signal outputs available
- Compact size and rugged construction
- All stainless steel design
- Integral electrical connection

Description

Compact, rugged design

The F-2X series of pressure transmitters are designed for installation in difficult, corrosive environments. The smooth exterior surfaces reduce areas where contaminants may collect and make it ideal for use in the food and pharmaceutical industries where wash-down procedures for cleanliness are required.

The all stainless steel case meets NEMA 4X requirements for wash-down and corrosion resistance and ingress protection is available up to IP 67.

Easily accessible electrical connection

The sophisticated design of this transmitter provides for fast, easy installation. The junction box cover unscrews for access to the internal spring clip terminal block.



Left: F-20 with standard NPT connection
Right: F-21 with flush diaphragm

Additional features

Transmitters with the 4-20mA output signal include an internal test circuit connection that permits the transmitter to be tested without disconnecting the primary 4-20 mA circuit. The model F-20 features an all-welded stainless steel measuring cell for improved media compatibility. There are no internal soft sealing materials that may react with the media or deteriorate over time.

The model F-21 features a flush diaphragm process connection. This flat sensing surface is specifically designed for the measurement of viscous fluids or media containing solids that may clog the NPT process connection.

Specifications

Model F-20 / F-21

Pressure range	50 InWC	5 psi	10 psi	25 psi	30 psi	60 psi	100 psi	160 psi	200 psi
Maximum pressure*	15 psi	29 psi	58 psi	145 psi	145 psi	240 psi	500 psi	1,160 psi	1,160 psi
Burst pressure**	29 psi	35 psi	69 psi	170 psi	170 psi	290 psi	600 psi	1,390 psi	1,390 psi
Pressure range	300 psi	500 psi	1,000 psi	2,000 psi	3,000 psi	5,000 psi	8,000 psi	10,000 psi ¹	15,000 psi ¹
Maximum pressure*	1,160 psi	1,160 psi	1,740 psi	4,600 psi	7,200 psi	11,600 psi	17,400 psi	17,400 psi	21,750 psi
Burst pressure**	1,390 psi	5,800 psi	7,970 psi	14,500 psi	17,400 psi	24,650 psi	34,800 psi	34,800 psi	43,500 psi

(vacuum, gauge pressure, compound ranges, and absolute pressure references are available)

¹ Ranges only available with Type F-20

² For Model F-21 the burst pressure is limited to 21,000psi unless the pressure seal is accomplished by using the sealing ring underneath the hex.

*Pressure applied up to the maximum rating will cause no permanent change in specifications but may lead to zero and span shifts

**Exceeding the burst pressure may result in destruction of the transmitter and possible loss of media

Materials		
■ Wetted parts		(for other materials see WIKA diaphragm seal program)
> Models F-20		Stainless steel
> Models F-21		Stainless steel; O-ring: NBR {Viton® or EPDM}
■ Case		Stainless steel
Internal transmission fluid ³⁾		Synthetic oil {Halocarbon® oil for oxygen applications} ⁴⁾ {Listed by FDA for food applications}

³⁾ Not available with F-20 on pressure ranges >300 psi

⁴⁾ Media temperature for oxygen version: -4 ... +140 °F / -20 ... +60 °C

Not available in vacuum and absolute pressure ranges or with Model F-21 flush diaphragm version > 500 psi

Power supply U _B	DC V	10 < U _B ≤ 30 (11 ... 30 with signal output 4 ... 20 mA, 14 ... 30 with signal output 0 ... 10 V)
Signal output and maximum load R _A		4 ... 20 mA, 2-wire R _A ≤ (U _B - 11 V) / 0.02 A with R _A in Ohm and U _B in Volt 0 ... 20 mA, 3-wire R _A ≤ (U _B - 3 V) / 0.02 A with R _A in Ohm and U _B in Volt {0 ... 5 V, 3-wire} R _A > 5 kOhm, {0 ... 10 V, 3-wire} R _A > 10 kOhm
Test circuit signal / max. load R _A		Only for instruments with 4 ... 20 mA signal output. R _A < 15 Ohm
Adjustability zero/span	%	± 5 using potentiometers inside the instrument
Response time (10 ... 90 %) ⁷⁾	ms	≤ 1
Isolation voltage	DC V	500
Accuracy ⁵⁾	% of span	≤ 0.25 {0.125} ⁶⁾ (BFSL)
	% of span	≤ 0.5 {0.25} ⁶⁾ (limit point calibration)

⁵⁾ Including linearity, hysteresis and repeatability. Limit point calibration performed in vertical mounting position with pressure connection facing down.

⁶⁾ For pressure ranges above 100 InWC

Non-linearity	% of span	≤ 0.2 (BFSL) according to IEC 61-298-2
Non-repeatability	% of span	≤ 0.1
1-year stability	% of span	≤ 0.2 (at reference conditions)
Permissible temperature of		
■ Medium		-22 ... +212 °F {-40 ... +257 °F} ⁷⁾ -30 ... +100 °C {-40 ... +125 °C} ⁷⁾
■ Ambient		-4 ... +176 °F {-22 ... +221 °F} -20 ... +80 °C {-30 ... +105 °C} ⁷⁾
■ Storage		-40 ... +212 °F -40 ... +100 °C
Compensated temperature range		32 ... +176 °F 0 ... +80 °C

Also complies with EN 50178, Tab. 7, Type C, Class 4KH Operation, 1K4 Storage, 1K3 Transport

⁷⁾ Response time F-20: ≤ 10 ms at medium temperatures below -30 °C (-22 °F) for pressure ranges up to 300 psi

Response time F-21: ≤ 10 ms at medium temperatures below -30 °C (-22 °F)

Temperature coefficients (TC) within compensated temperature range:		
■ Mean TC of zero	% of span	≤ 0.2 / 10 K (<0.4 for pressure range ≤ 100 InWC)
■ Mean TC of range	% of span	≤ 0.2 / 10 K
CE- conformity		
■ Pressure equipment directive		97/23/EC
■ EMC directive		89/336/EEC emission (class B) and immunity according to EN 61 326
Shock resistance	g	600 according to IEC 60028-2-27 (mechanical shock)
Vibration resistance	g	10 according to IEC 60068-2-6 (vibration under resonance)
Wiring protection		Protected against reverse polarity, overvoltage and short circuiting
Electrical connection		Internal spring clip terminals; wire cross section 2.5 mm ² max, internal ground Terminal for brass nickel-plated or {stainless steel} threaded connection {additional external ground terminal for stainless steel threaded conduit connection}
Weight	lb	Approx. 0.75

{ } Items in curved brackets are optional extras at additional cost.

Dimensions in inches (mm)

**1/2 NPT female conduit:
Ingress protection
NEMA 4X / IP 67**

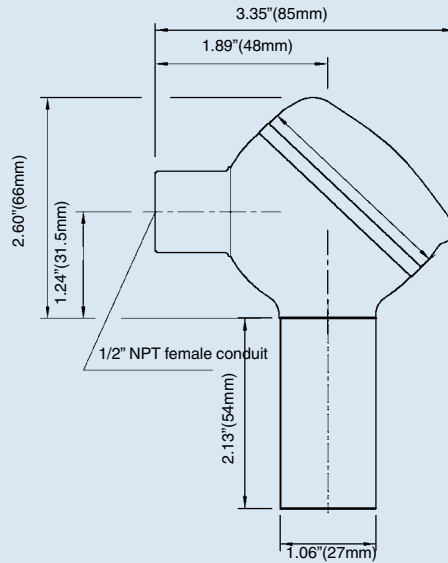

**Optional cable gland:
Ingress protection
IP 67 NEMA 4**

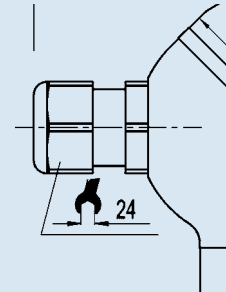

F-20 Pressure connections

1/2 NPT male
Order code: ND

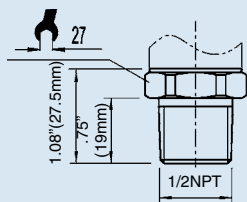

1/4 NPT male
Order code: NB

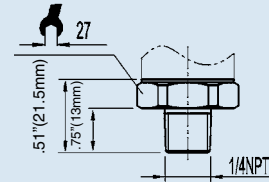

Other connections available

G 1/2 male
EN 837
Order code: GD

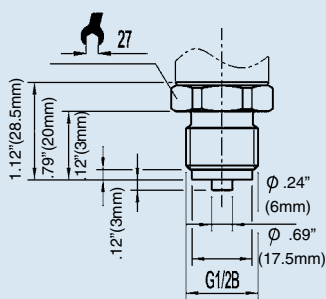

G 1/4B male
Order code: GB

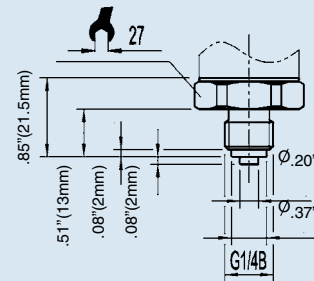

F-21 flush diaphragm pressure connections

G 1B
50 InWC to 25 psi
Order code: 85

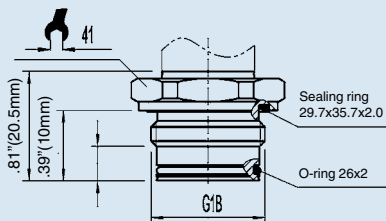

G 1/2B
30 psi to 8,000 psi
Order code: 86

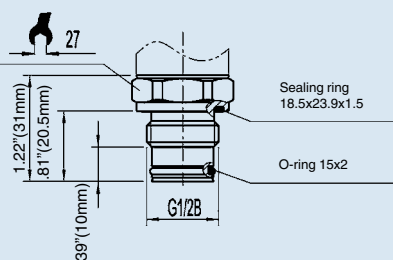

G 1
according to EHEDG *)
100 InWC to 250 psi
Order code: 84

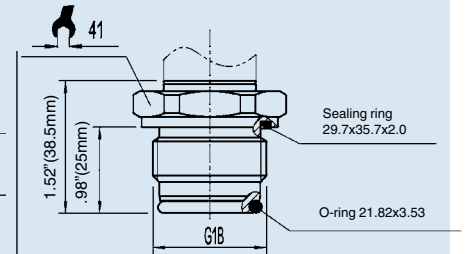

*) European Hygienic Equipment Design Group

Matching P-1 weld insert adapters for F-21 flush diaphragm transmitters

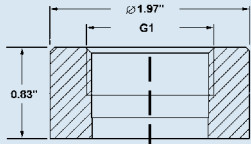

P-1 G1 weld insert adapter
Part # 1206974
for pressure ranges ≤ 25 psi

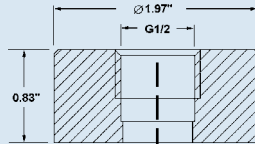

P-1 G1/2 weld insert adapter
Part # 1097008
for pressure ranges ≥ 30 psi

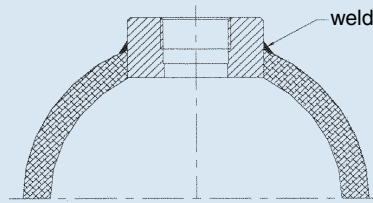

Cross section view of P-1 adapter installed in pipe.

Wiring

2-wire system

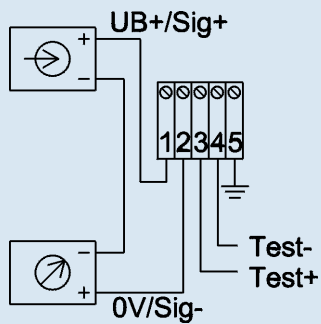

3-wire system

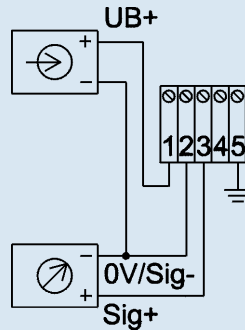

Legend:

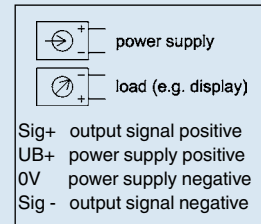

Calibration

Remove the junction box cover. Attach a meter and power supply to the electrical connector. For gauge ranges the zero potentiometer can be adjusted to produce a null output when no pressure is applied. Span adjustment requires the use of a reference pressure source. Compound and absolute ranges require a vacuum and pressure source. When calibration is complete, reinstall the junction box cover hand tight.

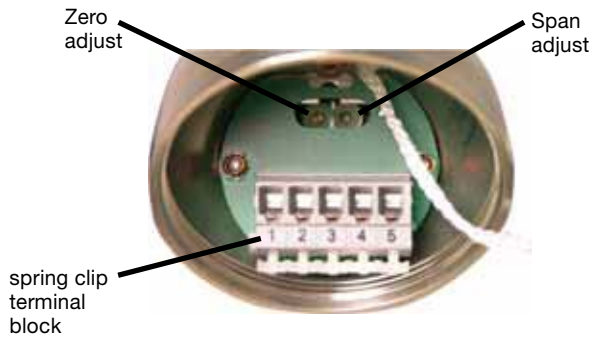

Related products:

Integral junction box version for installation in hazardous environments



Models IS-20-F, IS-21-F
see datasheet IS-20

Specifications and dimensions provided in this data sheet represent the state of engineering at the time of printing. Modifications may take place and materials specified may be replaced by others without prior notice.



WIKA Instrument Corporation
1000 Weigand Boulevard
Lawrenceville, Georgia 30043-5868
Tel: 770-513-8200 Fax: 77-338-5118
wika.com e-mail: info@wika.com