

Intrinsically Safe Hazardous Area Transmitter Type IS-20, IS-21, IS-20-F, IS-21-F

INSTRUMENTS • CONTROLS • VALVES

CLICK TO VISIT OUR WEBSITE

ARCO

3317 Gilmore Industrial Blvd.
Louisville, KY 40213

Engineering, Inc.
SINCE 1954
www.arcoengineering.com

Ph: (502) 966-3134
Fx: (502) 966-3135

Applications

- Chemical, Petrochemical
- Oil and gas refining
- Food industry
- Mechanical engineering

Special Features

- Pressure ranges from 50 InWC to 15,000 psi
 - FM, CSA approval for
 - Intrinsically safe Class I, II and III Division 1, Group A, B, C, D, E, F, G
 - Dust Class II and III Division 1, Group E, F, G
 - Class I, Zone 0, AEx ia II C
 - Ex- protection EEx ia I/II C T6 according to ATEX for:
 - Gases, vapors and mist: Connection to Zone 0, Zone 1 and Zone 2
 - Dust: Connection to Zone 20, Zone 21 and Zone 22
 - Mining: Category M1 and M2
- Suitable for SIL 2 according to IEC 61508 / IEC 61511



Left: IS-20-S standard version
Center: IS-21-S with flush diaphragm
Right: IS-20-F with integral junction box

Approvals meet international standards

The IS-20 series of intrinsically safe pressure transmitters are designed for industrial pressure measurement applications in hazardous areas where intrinsically safe ratings are required.

Multiple intrinsically safe approvals include FM, ATEX and CSA. These multiple approvals provide for global recognition and acceptance of the intrinsically safe ratings. The transmitters are labeled with all three approvals to help support international shipments of OEM equipment designed with these transmitters.

Rugged construction

The stainless steel wetted parts feature an all-welded measuring cell for improved media compatibility. There are no internal soft sealing materials that may react with the media or deteriorate over time. The compact case is also made of stainless steel and is available with environmental protection ratings up to NEMA 6 (IP 68).

The IS-21-S and IS-21-F transmitters feature a flush diaphragm process connection. They are specifically designed for the measurement of viscous fluids or media containing solids that may clog a NPT process connection.

Types IS-20-F and IS-21-F feature an integral stainless steel junction box with internal terminal block for use in extremely harsh environments. A 1/2" NPT female conduit connection is standard on all models and a cable compression electrical connection is available as an option.

All types require a 10 to 30 volt supply provided by an intrinsically safe power supply or through an approved intrinsically safe zener diode barrier.

Specifications

Type IS-20-S, IS-21-S, IS-20-F, IS-21-F

Specifications without type designation apply for all types.

Pressure range	50 InWC	5 psi	10 psi	25 psi	30 psi	60 psi	100 psi	160 psi	200 psi
Maximum pressure*	15 psi	29 psi	58 psi	145 psi	145 psi	240 psi	500 psi	1,160 psi	1,160 psi
Burst pressure**	29 psi	35 psi	69 psi	170 psi	170 psi	290 psi	600 psi	1,390 psi	1,390 psi
Pressure range	300 psi	500 psi	1,000 psi	2,000 psi	3,000 psi	5,000 psi	8,000 psi	10,000 psi ¹	15,000 psi ¹
Maximum pressure*	1,160 psi	1,160 psi	1,740 psi	4,600 psi	7,200 psi	11,600 psi	17,400 psi	17,400 psi	21,750 psi
Burst pressure**	1,390 psi	5,800 psi	7,970 psi	14,500 psi	17,400 psi	24,650 psi ²	34,800 psi ²	34,800 psi	43,500 psi

{vacuum, gauge pressure, compound ranges, and absolute pressure references are available}

¹) Ranges only available with Type IS-20

²) For Type IS-21 the burst pressure is limited to 21,000 psi unless the pressure seal is accomplished by using the sealing ring underneath the hex.

*Pressure applied up to the maximum rating will cause no permanent change in specifications but may lead to zero and span shifts

**Exceeding the burst pressure may result in destruction of the transmitter and possible loss of media

Materials

<ul style="list-style-type: none"> ■ Wetted parts ➤ Models IS-20-S, IS-20-F ➤ Models IS-21-S, IS-21-F 		(for other materials see WIKA diaphragm seal program) Stainless steel
<ul style="list-style-type: none"> ■ Case 		Stainless steel
Internal transmission fluid ³⁾		Synthetic oil {Halocarbon® oil for oxygen applications} ⁴⁾ {Listed by FDA for food applications}

³⁾ Not available with Type IS-20 in pressure ranges > 300 psi

⁴⁾ Media temperature for oxygen version: -4 ... +140 °CF (-20 ... +60 °C). Not available in vacuum or absolute pressure ranges or in Type IS-21 flush diaphragm version > 500 psi

Power supply U _B	DC V	10 < U _B ≤ 30 (11 < U _B ≤ 30 with Type IS-20-F)
Signal output and Maximum load R _A		4 ... 20 mA, 2-wire
<ul style="list-style-type: none"> ➤ Models IS-20-S ➤ Models IS-20-F 		$R_A \leq (U_B - 10 V) / 0.02 A$ – (length of cable in feet x 0.043 Ohm) $R_A \leq (U_B - 11 V) / 0.02 A$ with R _A in Ohms and U _B in Volts
Test circuit signal / max. load R _A		R _A < 15 Ohm (only for Type IS-20-F)
Adjustability zero/span	%	± 5 using potentiometers inside the instrument
Response time (10 ... 90 %)	ms	≤ 1 (≤ 10 ms at media temperatures below -22°F (-30°C) for ranges < 300 psi
Power P _i	W	1 (750 mW with approval for Category 1D)
Isolation voltage		Isolation complies with EN 50020, 79-11

Accuracy ⁵⁾	% of span	≤ 0.25 {0.125} ⁶⁾ (BFSL)
	% of span	≤ 0.5 {0.25} ⁶⁾ (limit point calibration)

⁵⁾ Including non-linearity, hysteresis and repeatability.

Limit point Calibration performed in vertical mounting position with pressure connection facing down.

⁶⁾ For pressure ranges above 100 InWC

Non-linearity	% of span	≤ 0.2 (BFSL) according to IEC 61298-2
Non-repeatability	% of span	≤ 0.1
1-year stability	% of span	≤ 0.2 (at reference conditions)

Permissible temperature	<ul style="list-style-type: none"> ■ Medium ^{7) 8)} 	-20 ... +80 °C ⁷⁾	-4 ... +176 °F ⁷⁾
		{extended temperature ranges see page 6} ⁷⁾	
	<ul style="list-style-type: none"> ■ Ambient ^{7) 8)} ■ Storage ⁸⁾ 	-20 ... +80 °C ⁷⁾	-4 ... +176 °F ⁷⁾

⁷⁾ Other temperature ranges are possible, depending on the electrical connection; see EC-type

⁸⁾ Also complies with EN 50178, Tab. 7, Type C, Class 4KH Operation, 1K4 Storage, 1K3 Transport

⁹⁾ Response time for IS-20: ≤ 10 ms at medium temp. below -30 °C (-22 °F) for pressure ranges up to 300 psi
Response time for IS-21: ≤ 10 ms at medium temp. below -30 °C (-22 °F) for all pressure ranges

Compensated temperature range		32 ... +176 °F	0 ... +80 °C
Temperature coefficients (TC) within compensated temperature range:			
<ul style="list-style-type: none"> ■ Mean TC of zero ■ Mean TC of range 	% of span	≤ 0.2 / 10 K (< 0.4 for pressure range ≤ 100 InWC)	
CE-conformity			
<ul style="list-style-type: none"> ■ Pressure equipment directive ■ EMC directive 		97/23/EC 2004/108/EC, EN 61 326 Emission (Group 1, Class B) and Immunity (industrial locations)	

Specifications

Type IS-20-S, IS-21-S, IS-20-F, IS-21-F

■ Directive ATEX of equipment intended for use in potentially explosive atmospheres		94/9/EC
Ex-protection	ATEX	Category ⁸⁾ 1G, 1/2G, 2G, 1D, 1/2D, 2D, M1, M2
Ignition protection type		Ex ia I/II C T4, Ex ia I/II C T5, Ex ia I/II C T6
		⁸⁾ Read the operating conditions and safety-relevant data in the EC-type examination certificate in any case (BVS 04 ATEX E 068 X)
Ex-protection	FM, CSA	Class I, II and III
Ignition protection type		Intrinsic safe Class I, II, III Division 1, Group A, B, C, D, E, F, G and Class I, Zone 0 AEx ia II C
HF-immunity	V/m	10
Burst	kV	2
Functional safety		Suitable for SIL 2 applications according to IEC 61508/ IEC 61511 Further information: "Additional Instructions Safety-related data IS-2X SIL"
Shock resistance		
» Type IS-2X-S	g	1,000 according to IEC 60068-2-27 (mechanical shock)
» Type IS-2X-F	g	600 according to IEC 60068-2-27 (mechanical shock)
Vibration resistance		
» Type IS-2X-S	g	20 according to IEC 60068-2-6 (vibration under resonance)
» Type IS-2X-F	g	10 according to IEC 60068-2-6 (vibration under resonance)
Wiring protection		
■ Short-circuit		Sig+ towards UB-
■ Reverse polarity		UB+ towards UB-
Weight		
> Type IS-2X-S	lb	Approx. 0.45
> Type IS-2X-F	lb	Approx. 0.80

*) In an oxygen version type IS-21 is not available. In an oxygen version type IS-20 is only available in gauge pressure ranges ≥ 0.25 bar with media temperatures between $-20 \dots +60$ °C / $-4 \dots +140$ °F and using stainless steel or Elgiloy® wetted parts.

{ } Items in curved brackets are optional extras for additional price.

Output signal and permissible load

Type IS-2X-S

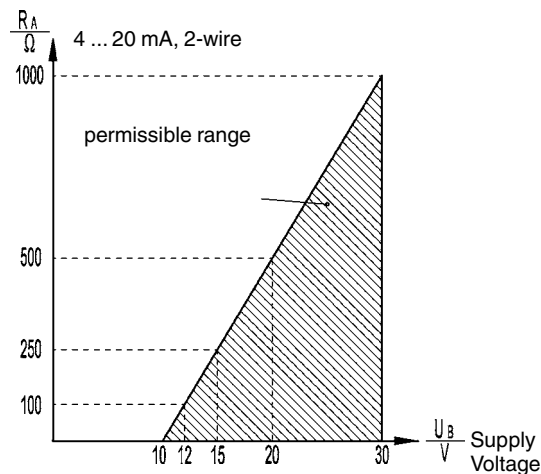

Output current (2-wire)

$$4 \dots 20 \text{ mA: } R_A \leq (U_B - 10 \text{ V}) / 0.02 \text{ A}$$

Type IS-2X-F

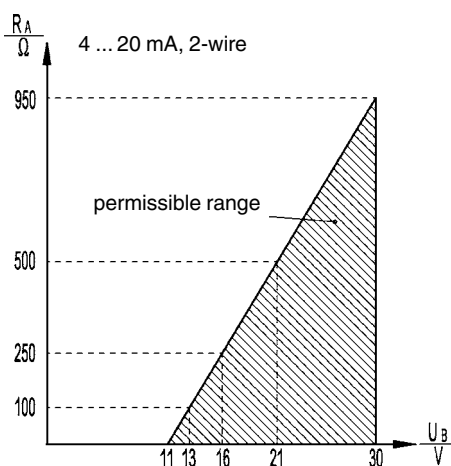

Output current (2-wire)

$$4 \dots 20 \text{ mA: } R_A \leq (U_B - 11 \text{ V}) / 0.02 \text{ A}$$

Dimensions in inches (mm)

IS-2X-S (electrical connections)

Ingress Protection IP per IEC 60 529

L-connector plug
DIN EN 175301-803,
Form A
½ NPT conduit
IP 65
Order code: AX
ATEX: 1/2 G, M1

Circular connector,
M 12x1, 4-pin
IP 67
Order code: M4
ATEX: 1/2 G, M1

Cable with free ends
outer conductor
diameter 6.8 mm, PUR
NEMA 4 / IP 67
Order code: DL
ATEX: 1/2 G, M1

Bayonet connector
6-pin NEMA 4 / IP 67
Order code: C6
ATEX: 1/2 G
(not available with min-
ing approval)

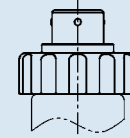
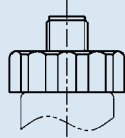
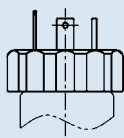
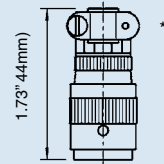
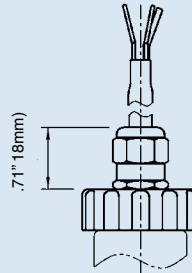
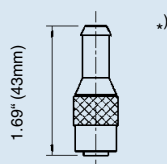
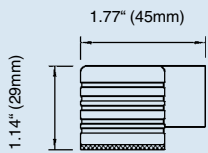

Case

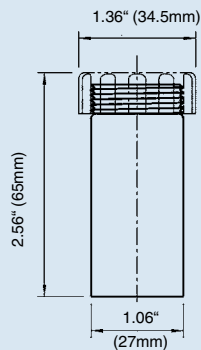

Pressure connections IS-20-S and IS-20-F

1/2 NPT male
Order code: ND

1/4 NPT male
Order code: NB

G 1/2 metric
EN 837
Order code: GD

G 1/4 metric
EN 837
Order code: GB

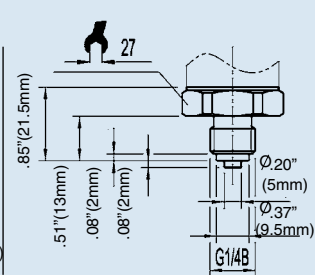
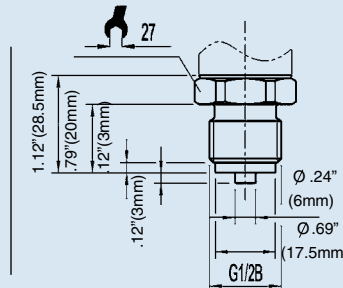
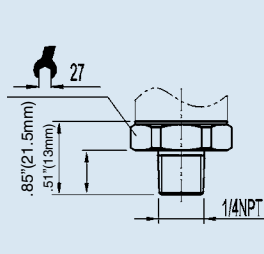
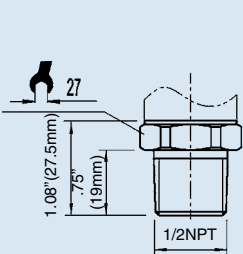

Electrical connections IS-2X-S

Cable with free ends, zero/span not adjustable, conductor outer diameter 6.8 mm, PUR IP 68/NEMA 6
Order code: EM
ATEX: 1/2 G, M1

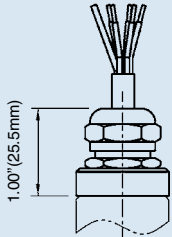

Other connections available

Electrical connections IS-2X-F

Integral junction box with internal spring clip terminals NEMA 4X IP 67
Order code:
FE (1/2" NPT female conduit standard)
FH (threaded connection brass nickel-plated)
FC (threaded connection stainless steel)
ATEX: 1/2 G, M1

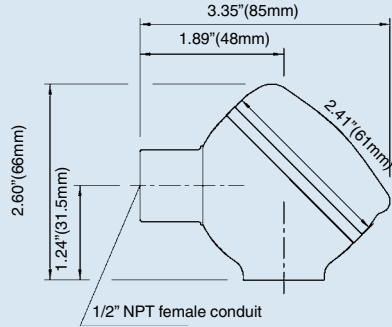

Electrical connections IS-2X-S

Cable with free ends, zero/span not adjustable, conductor outer diameter 7.5 mm, PUR {FEP} NEMA 6P / IP 68
Order code: DM
ATEX: 1G, 1D, M1

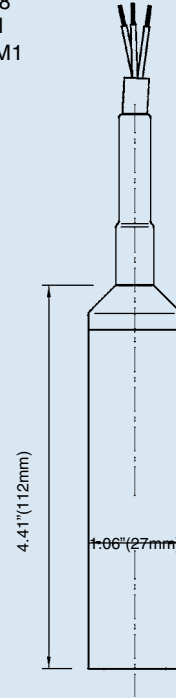

Case dimensions

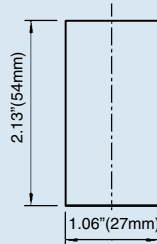

IS-21-S and IS-21-F flush diaphragm pressure connections

G 1
50 InWC to 25 psi
Order code: 85

G 1/2
30 psi to 8,000 psi
Order code: 86

G 1
according to EHEDG **)
100 InWC to 250 psi
Order code: 83

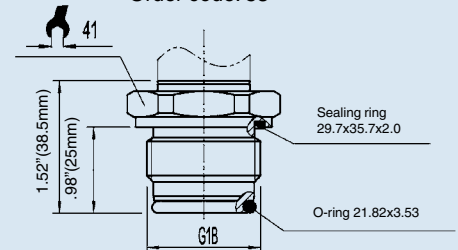
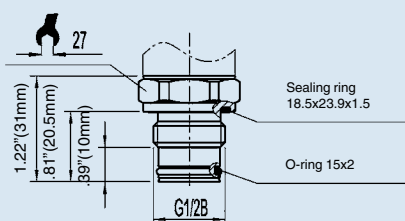
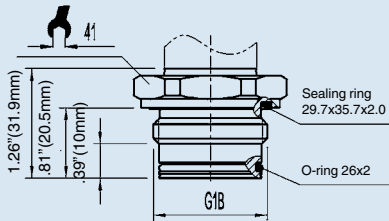

Matching P-1 weld insert adapters for IS-21-S and IS-21-F transmitters

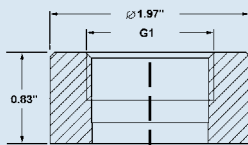

P-1 G1 weld insert adapter
Part # 1206974
for pressure ranges ≤ 25 psi

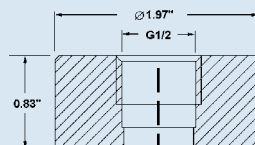

P-1 G1/2 weld insert adapter
Part # 1097008
for pressure ranges ≥ 30 psi

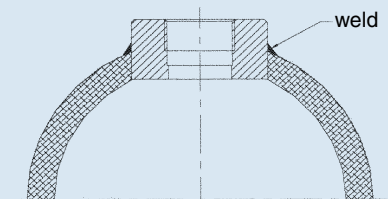

Cross section view of P-1 adapter installed in pipe.

** European Hygienic Equipment Design Group

{ } Items in curved brackets are optional extras at additional cost.

Pressure connections for high temperature media

IS-21-S and IS-21-F, flush diaphragm
-4 °F to 302 °F (-20 °C to 150 °C)

G 1/2
with 2 cooling fins (version **(A)**)
0 ... 30 psi up to 0 ... 8000 psi
Order code: 86 and C

IS-20-S and IS-20-F
-40 °F to 302 °F (-40 °C to 150 °C)

1/2 NPT male
with 3 cooling fins (version **(B)**)
0 - 5 psi to 0-15,000 psi
Order code: ND and 8

IS-20-S and IS-20-F
-40 °F to 392 °F (-40 °C to 200 °C)

1/2 NPT male
with 5 cooling fins (version **(C)**)
0-5 psi to 0-15,000 psi
Order code: ND and 9

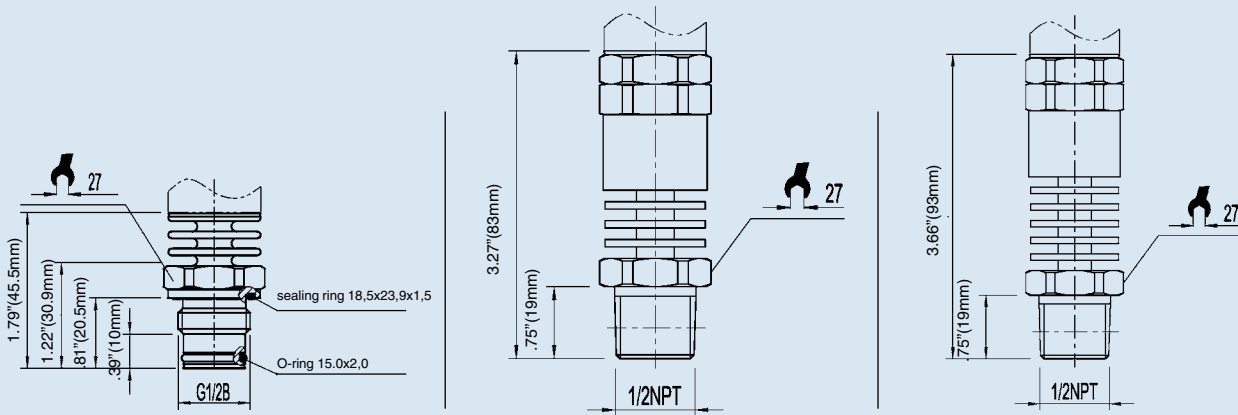

Relationship of media temperature to ambient temperature

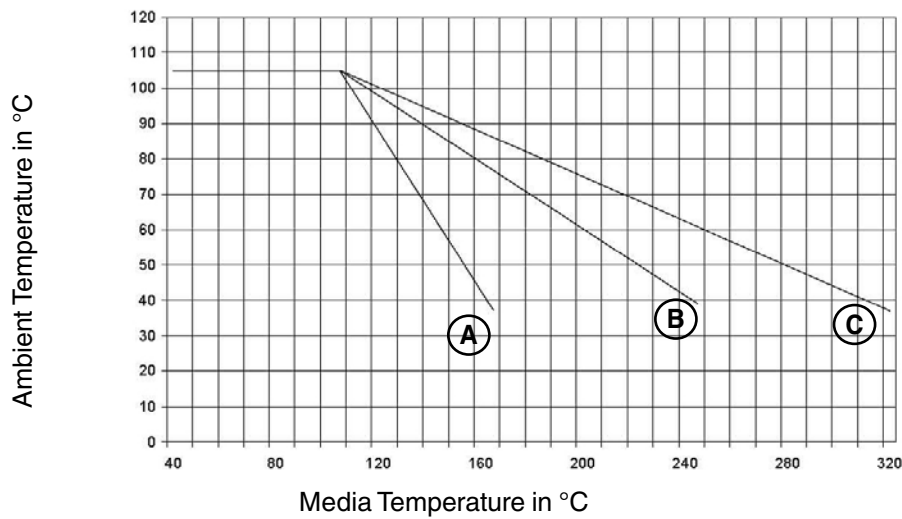

Version	(A)	(B)	(C)
Cooling fins	2	3	5
K *	0.47	0.68	0.76

*cooling constant specific to each version

Calculation of cooling element performance:

$$T_B = T_{med} - (T_{med} - T_{amb}) \times K$$

T_B = Operating temperature of transmitter
 T_{med} = maximum temperature of process media
 T_{amb} = maximum ambient temperature
 K = Constant of cooling element





Maximum permissible ambient temperature:

$$T_{amb} = T_{med} + (T_B - T_{med}) / K$$

Permissible temperature ranges depending on electrical connections

Electrical connections	Order-code	Category	Ambient/Medium temperature range	
DIN 175301-803 A L-Connector	A4	1/2 G (IIC)	-40 ... +140 °F (T6) -40 ... +176 °F (T5) -40 ... +221 °F (T4)	-40 ... +60 °C (T6) -40 ... +80 °C (T5) -40 ... +105 °C (T4)
		M1	-40 ... +221 °F	-40 ... +105 °C
M 12x1 Circular connector	M4	1/2 G (IIC)	-13 ... +140 °F (T6) -13 ... +176 °F (T5) -13 ... +194 °F (T4)	-25 ... +60 °C (T6) -25 ... +80 °C (T5) -25 ... +90 °C (T4)
		M1	-13 ... +194 °F	-25 ... +90 °C
Cable	DL	1/2 G (IIC)	-4 ... +140 °F (T6) -4 ... +176 °F (T5) -4 ... +176 °F (T4)	-20 ... +60 °C (T6) -20 ... +80 °C (T5) -20 ... +80 °C (T4)
		M1	-4 ... +140 °F	-20 ... +60 °C
Bayonet connector (not with mining)	C6	1/2 G (IIC)	-58 ... +140 °F (T6) -58 ... +176 °F (T5) -58 ... +221 °F (T4)	-50 ... +60 °C (T6) -50 ... +80 °C (T5) -50 ... +105 °C (T4)
Cable zero/span not adjustable	EM	1/2 G (IIC)	-4 ... +140 °F (T6) -4 ... +176 °F (T5) -4 ... +176 °F (T4)	-20 ... +60 °C (T6) -20 ... +80 °C (T5) -20 ... +80 °C (T4)
		M1	-4 ... +176 °F	-20 ... +80 °C
Fieldcase	FE, FH, FC	1/2 G (IIC)	-58 ... +140 °F (T6) -58 ... +176 °F (T5) -58 ... +221 °F (T4)	-50 ... +60 °C (T6) -50 ... +80 °C (T5) -50 ... +105 °C (T4)
		M1	-58 ... +221 °F (T4)	-50 ... +105 °C (T4)
PUR Cable zero/span not adjustable	DM	1 G (IIA), 1/2 G (IIC)	14 ... +140 °F (T6) 14 ... +140 °F (T5) 14 ... +140 °F (T4)	-10 ... +60 °C (T6) -10 ... +60 °C (T5) -10 ... +60 °C (T4)
		1D, M1	14 ... +140 °F	-10 ... +60 °C
FEP Cable zero/span not adjustable	DM	1 G (IIA), 1/2 G (IIC)	-22 ... +140 °F (T6) -22 ... +176 °F (T5) -22 ... +221 °F (T4)	-30 ... +60 °C (T6) -30 ... +80 °C (T5) -30 ... +105 °C (T4)
		1D	-22 ... +140 °F	-30 ... +60 °C
		M1	-22 ... +221 °F	-30 ... +105 °C

Wiring details

	L-connector DIN 175301-803 A	Circular connector M12x1, 4 pin	Cable, 1.5 m
			
2-wire	U+ = 1 U- = 2	U+ = 1 U- = 3	U+ = brown U- = green
Cable screen			PUR-cable: grey FEP-cable: twisted and tinned
Wire gauge	up to max. 1.5 mm ²	-	0.5 mm ² (AWG 20)
Cable diameter	6-8 mm ship approval: 10-14 mm	-	6.8 mm (Order code: DL / EM) 7.5 mm (Order code DM)
Ingress protection according to IEC 60 529	IP 65	IP 67	IP 67 - Order code: DL IP 68 zero/span not adjustable - Order code: EM / DM
The ingress protection classes specified only apply while the pressure transmitter is connected with female connectors that provide the corresponding ingress protection.			
	Bayonet connector, 6 pin	Field case (with internal spring clip terminals)	
			
2-wire	U+ = A U- = B	U+ = 1 U- = 2	Test+ = 3 Test- = 4 screen = 5
Cable diameter		7-13 mm	
Ingress protection according to IEC 60 529	IP 67	IP 67	
The ingress protection classes specified only apply while the pressure transmitter is connected with female connectors that provide the corresponding ingress protection.			

Hazardous areas (ATEX zone classifications)

Group II: Electrical equipment for use in all areas (except mines) which are endangered by an explosive atmosphere.

Zone	Category	Occurrence of explosive atmosphere
Zone 0	Category 1G (gas)	Continuous
Mounting to zone 0	Category 1/2 G	
Zone 20	Category 1D (dust)	
Mounting to zone 20	Category 1/2 D	
Zone 1	Category 2G	Intermittent
Zone 21	Category 2D	
Zone 2	Category 3G	Hazard under abnormal conditions
Zone 22	Category 3D	

Group I: Electrical equipment for use in mines (hazard due to mine gas)

Zone	Category	Requirements
	Category M 1	Very high degree of safety
	Category M 2	High degree of safety (instruments have to be turned off if they are exposed to an explosive atmosphere)

Hazardous areas (ATEX in comparison with FM, CSA)

	ATEX		FM / CSA	
	Group		Class	Group
<i>Above ground</i>	Gases and Vapors	IIA / IIB / IIC	I	A / B / C / D / E / F / G
	Dusts		II	
	Fibers		III	
<i>Mining</i>	Gas / Dusts	I	ID / IIF	

ATEX	Zone 0 (Zone 20 Dust)	Zone 1 (Zone 21 Dust)	Zone 2 (Zone 22 Dust)
FM / CSA	Zone 0	Zone 1	Zone 2
	Division 1		Division 2
FM (NEC505)	Zone 0	Zone 1	Zone 2

The specifications given in this document represent the state of engineering at the time of publishing. We reserve the right to make modifications to the specifications and materials.

