

Hazardous Area Non-incendive Transmitters Model N-10, N-11

INSTRUMENTS • CONTROLS • VALVES

CLICK TO VISIT OUR WEBSITE

ARCO

Engineering, Inc.
SINCE 1954

www.arcoengineering.com

3317 Gilmore Industrial Blvd.
Louisville, KY 40213

Ph: (502) 966-3134
Fx: (502) 966-3135



Applications

- Natural gas compressors
- Wellhead monitoring
- Pipeline pressure
- General industrial applications

Special Features

- FM approved Non-incendive for Class I Division 2 hazardous locations
- Engineered to meet the harsh demands of gas compressor applications
- Does not require the use of intrinsically safe barriers
- NACE MR-01-75 compliant wetted parts
- 4-20 mA or low power 1-5 volt output signals available

Description

Type N-10 pressure transmitters are specifically designed to meet the durability and performance requirements of gas compressor systems. These pressure transmitters feature an industry standard 4-20 mA 2 wire signal output, NEMA 4X (IP 67) weather protection and are extremely resistant to pressure spikes, vibration and moisture intrusion. NACE MR-01-75 compliance provides extra resistance against sulfide stress cracking when exposed to gases containing sulphur.

Type N-11 pressure transmitters feature a flat, non-clogging diaphragm. This is designed for use with viscous fluids or media containing particulates that could clog the pressure port of the standard NPT version.



Left: N-10 pressure transmitter with NPT connection
Right: N-11 flush diaphragm pressure transmitter

The transmitters are engineered to meet Class I Division 2 non-incendive protection requirements in hazardous environments. Each undergoes extensive quality control testing and calibration to achieve a linearity of $\leq 0.25\%$ full scale. In addition, each pressure transmitter is temperature compensated to assure accuracy and long term stability when exposed to severe ambient temperature variations.

Specifications

Type N-10 / N-11

Pressure range	5 psi	10 psi	15 psi	25 psi	30 psi	60 psi	100 psi	200 psi	300 psi
Maximum pressure*	29 psi	58 psi	72 psi	145 psi	145 psi	240 psi	500 psi	1,160 psi	1,160 psi
Burst pressure**	35 psi	69 psi	87 psi	170 psi	170 psi	290 psi	600 psi	1,390 psi	1,390 psi
Pressure range	500 psi	1,000 psi	1,500 psi	2,000 psi	3,000 psi	5,000 psi	8,000 psi ¹	10,000 psi ¹	15,000 psi ¹
Maximum pressure*	1,160 psi	1,740 psi	2,900 psi	4,600 psi	7,200 psi	11,600 psi	17,400 psi	17,400 psi	21,750 psi
Burst pressure**	5,800 psi	7,970 psi	11,600 psi	14,500 psi	17,400 psi	24,650 psi ²	34,800 psi	34,800 psi	43,500 psi

{vacuum, gauge pressure, compound ranges, and absolute pressure references are available}

Materials		
■ Wetted parts		Nace compliant ⁵
> N-10		Stainless steel (≥ 300 psi stainless steel and Elgiloy)
> N-11		Stainless steel; O-ring: NBR {Viton or EPDM}
■ Case		Stainless steel
Internal transmission fluid		Synthetic oil (only for pressure ranges up to 300 psi or flush diaphragm units)
Power supply U _B	DC V	10 < U _B ≤ 30 for 4 ... 20 mA, 2-wire 6 < U _B < 30 for 1 ... 5 V, 3-wire low power version
Signal output and maximum load R _A		4 ... 20 mA: R _A ≤ (U _B - 10 V) / 0,02 A with R _A in Ohm and U _B in Volt 1 ... 5 V, 3-wire: R _A > 10 kOhm
Response time (10 ... 90 %)	ms	≤ 1 (≤ 10 ms when media temperatures are below -22 ° F (-30 ° C) for pressure ranges up to 300 psi or with flush diaphragm)
Isolation voltage	V	500
Accuracy ³⁾	% of span	≤ 0.25 (BFSL)
	% of span	≤ 0.5 (limit point calibration)
Non-repeatability	% of span	≤ 0.05
Hysteresis	% of span	≤ 0.1
1-year stability	% of span	≤ 0.2 (at reference conditions)
Permissible temperature of		
■ Medium		-22 ... +212 ° F -30 ... +100 ° C
■ Ambient		-22 ... +212 ° F -30 ... +100 ° C
■ Storage		-22 ... +221 ° F -30 ... +105 ° C
Compensated temp. range		32 ... +176 ° F 0 ... +80 ° C
Temperature coefficients in compensated temp range:		
■ Mean TC of zero	% of span	≤ 0.2 / 10 K (< 0,4 for pressure range < 100 lnWC)
■ Mean TC of range	% of span	≤ 0.2 / 10 K
Approval authority		
		■ Factory Mutual (FM) non-incendive with entity approval for: Class 1, Division 2, Groups A, B, C, D
		■ Dust ignition-proof for Class II and III, Division 1, Groups E, F and G
		Maximum electrical ratings 30 V, 20 mA
		FM Standards according to FMRC 3600, 3611, 3810
HF-immunity	V/m	10
Burst	KV	4
Ingress protection		NEMA 4X (IP 67)
Shock resistance	g	1,000 according to IEC 60068-2-27 (mechanical shock)
Vibration resistance	g	20 according to IEC 60068-2-27 (vibration under resonant conditions)
Wiring protection		Protected against reverse polarity, overvoltage, and short circuiting
Weight	lb	0.4

* Pressure applied up to the maximum rating will cause no permanent change in specifications but may lead to zero and span shifts

**Exceeding the burst pressure may result in destruction of the transmitter

1) Only Type N-10.

2) For Type N-11: the burst pressure is limited to 21,000 psi unless the pressure seal is accomplished by using the sealing ring underneath the hex.

3) Includes non-linearity, hysteresis and repeatability. Limit point calibration performed in vertical mounting position with pressure connection facing down.

4) Transmitters will function when exposed to these extended temperature ranges. The media, when exposed to temperature extremes, may change characteristics that effect transmitter performance.

5) Wetted parts comply with recommendations per NACE MR0175. Environmental limits apply to certain materials. Consult latest standard for details.

{ } Items in curved brackets are options available at additional cost.

Dimensions in inches (mm)

Electrical connection

6 foot cable with free ends
NEMA 4 / IP 67
Order code: 2X

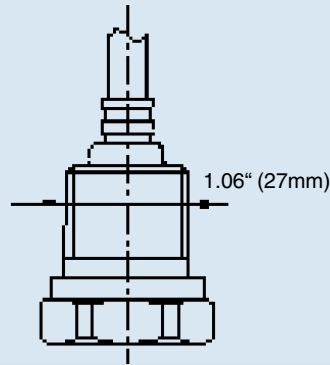

Case

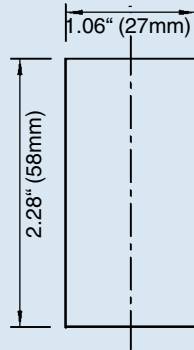

N-10 pressure connections

1/4 NPT male
Order code: NB

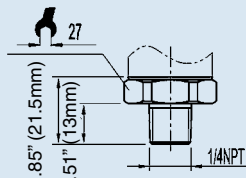

1/2 NPT male
Order code: ND

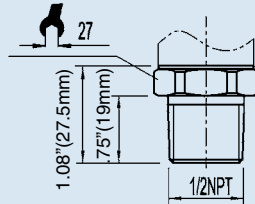

G 1/2
EN 837
Order code: GD

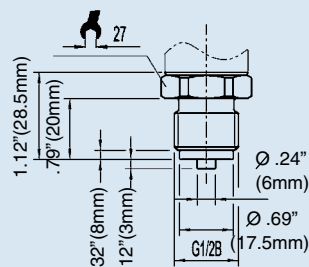

G 1/4
EN 837
Order code: GB

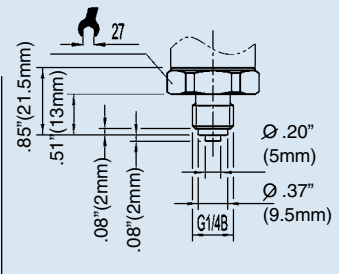

N-11 flush diaphragm pressure connections

N-11 G 1
50 InWC to 25 psi
Order code: 85

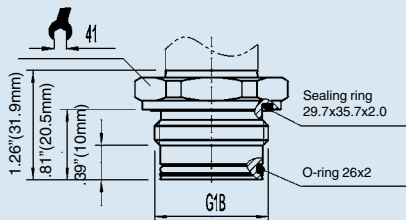

N-11 G 1/2
30 psi to 5,000 psi
Order code: 86

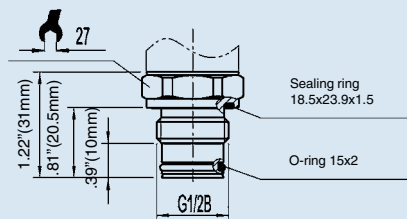

Matching P-1 weld insert adapters for N-11 flush diaphragm transmitters

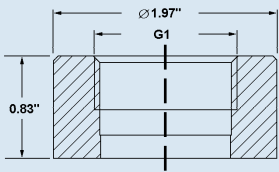

P-1 G1 weld insert adapter
Part # 1206974
for pressure ranges ≤ 25 psi

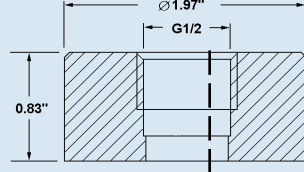

P-1 G1/2 weld insert adapter
Part # 1097008
for pressure ranges ≥ 30 psi

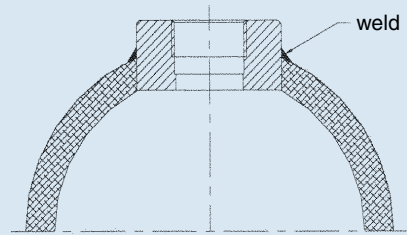

Cross section view of P-1
adapter installed in pipe.

Wiring details

2-wire system

6 foot cable with free ends

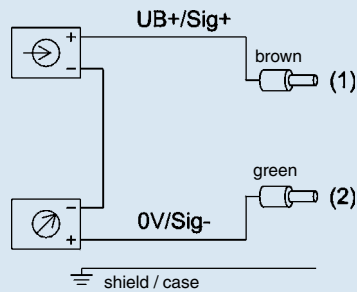

3-wire system

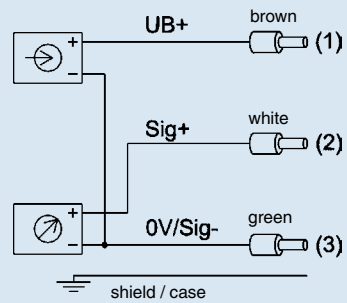

Legend:

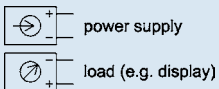

Sig+ - output signal positive
UB+ - power supply positive
0V - power supply negative
Sig- - output signal negative

